

Simon XTi Installation Guide

Content

Contact information	1
Description	1
Installation.....	1
Connecting hardwired devices.....	2
Wiring phone lines.....	3
Wiring the power transformer	4
Resetting memory to factory defaults	4
Programming.....	4
Status & Settings screen.....	5
Sensors	7
Cleaning the touch screen.....	9
Disposal	9
Specifications.....	10
Regulatory information.....	10

Contact information

www.utcfireandsecurity.com or www.interlogix.com

For customer support, see www.interlogix.com/customer-support

GE and the GE monogram are trademarks of the General Electric Company and are under license to UTC Fire & Security, 9 Farm Springs Road, Farmington, CT 06034-4065

Copyright © 2012 UTC Fire & Security. All rights reserved.

Description

This is the Installation Guide for the Simon XTi system (models 600-1054-95R-12 and 600-1054-95R-12-CN).

Table 1: Sensors and recommended sensor groups

Device	Part number	Recommended sensor group
Indoor motion sensor	60-639-95R, 60-807-95 ^b	15, 17, 18, 20, 28, or 32
Entry/exit door	60-362N-10-319.5	10
Interior door	60-362N-10-319.5	14
Door/Window sensor	60-362N-10-319.5	13
Smoke sensor	TX-6010-01-1 ^c	26
Glassbreak sensor	60-873-95 ^b	13



Device	Part number	Recommended sensor group
4-Button Key fob	600-1064-95R ^b	01
Simon XT Talking Touch Screen	60-924-3-XT-2WTTS ^b 60-924-RF-TS ^d	00, 01, 04, 05, 06, or 07
Simon XT Talking Touchpad	60-924-3-XT ^b	01
Carbon Monoxide alarm	TX-6310-01-1 ^b , 600-6520-95 ^b	34

- a. Not certified as a primary protection circuit for UL-listed systems and is for supplementary use only.
- b. Has not been investigated by UL.
- c. Required for UL-listed residential fire alarm applications.
- d. The TWTTTS has been verified for use by ETL. Neither this device nor other devices that employ the UTCFS 80 Bit Enhanced Protocol have been investigated for use by UL.

Note: These sensor groups are only recommendations. The installer should choose the correct sensor group for the application.

Caution: Do not use outdoor motion sensors for intrusion protection.

Installation

Panel location

Locate the panel where alarm sounds can be heard and where the panel will be easily accessible for operation. Do not install the panel near a window or door where it can be reached easily by an intruder.

Mounting

Figure 1: XTi chassis and trim ring

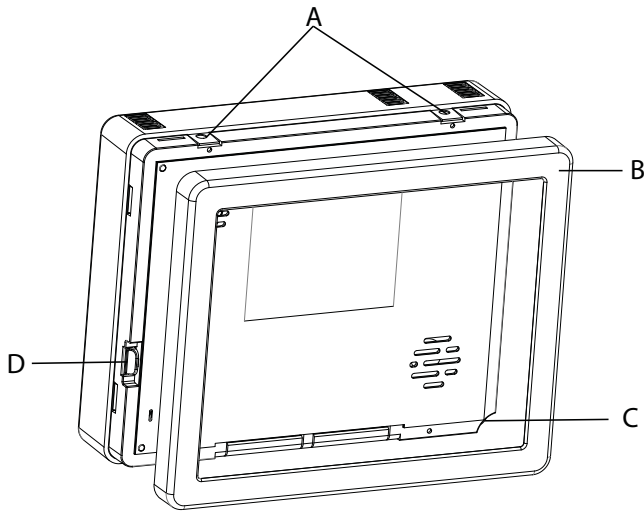

To mount the panel on a wall:

1. Lay the panel flat on a table.
2. Remove trim ring (B in Figure 1 above) from panel by lifting at notch (C in Figure 1 above).
3. Separate the panel chassis from the mounting plate by lifting up on the tabs (A in Figure 1 above) and swinging the chassis open.
4. Choose a panel location.
5. Run all necessary power, phone, siren, and hardwired contact wires to the desired panel location.

When choosing the AC outlet location for the AC power transformer, make sure the outlet is not controlled by a switch or that it is not part of a ground fault circuit interrupt (GFCI).

6. Hold the mounting plate against the wall and mark the mounting hole locations (Figure 2 below) with a pencil.

Note: Mark both mounting holes in the middle of the mounting slot. This will allow better adjustment of the panel before securing it to the wall.

Figure 2: Mounting holes

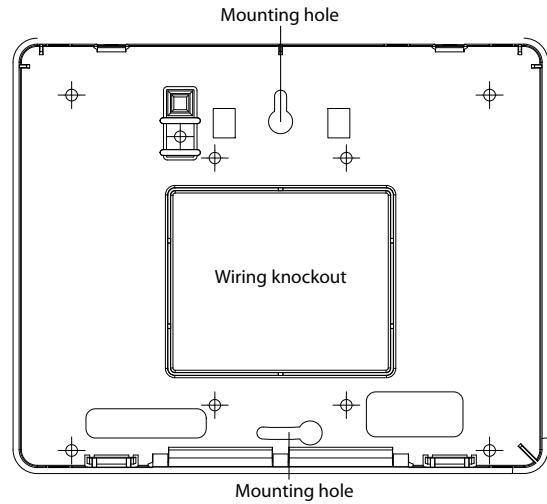

7. Secure the mounting screws (provided) to the locations on the wall marked in step 6. Do not tighten the screws. Leave enough clearance to mount the mounting plate.
- Note:** Use wall anchors if no studs are present.
8. Mount the mounting plate to the wall. Insert the top mounting hole first, then the bottom hole. Adjust the fit to make sure the mounting plate is level. Hold the mounting plate in place and tighten the screws.
 9. Hang the panel chassis on the mounting plate at the plastic hinges, swing the chassis up to the mounting plate and engage at the tabs (A in Figure 1 above).
 10. Reattach the trim ring.

Connecting hardwired devices

The panel has five screw terminals, two battery terminals, and two telephone connections. The screw terminals connect the AC power, sirens, and/or hardwired detectors.

Figure 3: Wiring terminals

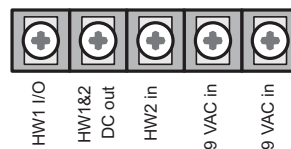

Program sensors and devices before you install them. Follow the instructions in "Sensors" on page 7 to add the sensors to panel memory.

The HW1 I/O terminal is dual purpose and can be used for either siren or hardwired contact connections. The HW2 in terminal is an input only.

Interior sirens

From the factory, the HW1 I/O input (terminal 1) is set up for interior siren operation (status and alarm sounds). The HW1&2 DC out (terminal 2) provides the positive (+) voltage.

Note: The total current available from the HW1&2 DC out terminal is 250 mA at up to 120°F (49°C). A 24-hour battery standby for UL requirements will be met with a maximum load of 250 mA.

With Hardwired Siren Supervision turned on, sirens connected to HW1 I/O are supervised and require a 4.7-kohm resistor in the circuit. If this terminal is not used, turn Hardwired Siren Supervision off.

Exterior sirens

For an exterior siren, change the HW1 setting in the System Options programming menu. See wiring diagram.

Note: Not investigated for and may not be used in a UL Listed installation.

Hardwired contacts

You can connect hardwired reed switches (normally closed loop only) to HW1 I/O (if not being used for a hardwired siren) and/or HW2 in (terminal 3).

Connect only normally closed (NC) reed switches to HW1 I/O and/or HW2 in. Other types of hardwired detectors should not be used.

The total resistance of the wired loop must not exceed 3 ohms. This allows you to use up to 200 ft. (61 m) of two-conductor, 22-gauge stranded wire.

Connect hardwired reed switches to the panel using a 47-kohm resistor (not a 4.7-kohm resistor) as shown in Figure 4 below. The resistor must be connected at the last switch in the circuit.

Figure 4: Normally closed hardwired reed switches

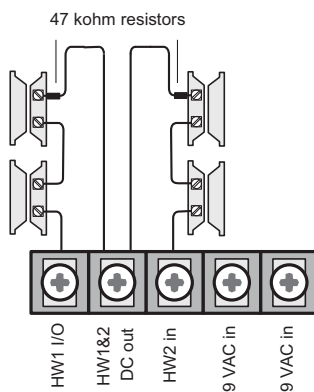

Note: Do not install the resistor at the panel terminals. This does not provide supervision of the wire.

Wiring phone lines

You can connect a phone line to the panel for systems monitored by a central monitoring station or systems that notify users by a voice event notification.

DSL (digital subscriber line) allows the use of multiple devices on a single phone line simultaneously. For DSL environments, connect the panel line-in jack to an available phone jack on the premises. You might also need an inline filter to ensure panel reporting is successful.

Note: Avoid connecting the panel to a standard phone (voice) line, as other devices on the line can prevent reports from going through.

Full line seizure

Full line seizure allows the panel to take over (seize) the phone line, even if another device on the line is in use. This method requires that the panel be wired before all other phones, answering machines, computers, or other devices on the phone line. You may need to verify the line seizure for UL installations.

Use the RJ31X (CA-38A) jack when wiring for full line seizure. You can then quickly and easily disconnect the panel from the phone line in case the panel disables the phone line due to a malfunction.

To wire full line seizure with an RJ31X:

1. Run a four-conductor cable from the premises Telco block to the RJ31X.
2. Connect the four-conductor cable wire to the RJ31X.
3. Disconnect the green and red premises phone jack wires from the Telco block and splice them to the four-conductor cable black and white (or yellow) wires. Use weatherproof wire connectors for these splices.
4. Connect the four-conductor cable green and red wires to the Telco block TIP (+) and red to RING (-) posts.
5. Connect the phone cord included with the panel to the RJ31X and the panel LINE jack.

Full line seizure wiring with one premises phone

If a single phone is all that exists on the premises, full line seizure can be accomplished without an RJ31X.

1. Disconnect the phone from the premises phone jack and plug it into the panel PHONE jack. This jack is disconnected automatically whenever the panel reports.
2. Connect the included phone cord to the panel LINE jack and the premises phone jack.

If a customer adds phones or other phone devices to another phone jack, full line seizure no longer exists. Inform them to

contact you if they want to add a phone or other device so that you can rewire for full line seizure by adding an RJ31X.

Wiring the power transformer

Connect the power transformer to the two 9 VAC in terminals (4 and 5) on the panel. Do not plug in the transformer at this time. When applying power to the panel, connect the battery first, and then plug in the AC power transformer. This sequence prevents a battery fault condition.

Note: System can only be powered up using AC power, not battery power. The red battery icon may appear when the system first powers up and will disappear after some time.

To remove and install the backup battery (6 VDC, 2.1 Ah):

Note: It is recommended that the backup battery be replaced every 3-5 years.

1. Remove AC power from the panel.
2. Disconnect the existing battery from the battery connector.
3. Remove the existing battery by reaching under the battery with a finger and pulling up.

Note: Do not try to push the plastic latch back to remove the battery.

4. Insert the new battery into the battery compartment and snap into place.
5. Plug the battery connector into the panel.

Caution: Do not connect the battery until you are ready to power up the panel.

Resetting memory to factory defaults

If you need to reset memory to factory defaults, follow the steps below.

To reset the panel to factory defaults:

1. Remove the trim ring.
2. Open the panel chassis.
3. Unplug the transformer and disconnect the battery.
4. Press and hold the reset button (D in Figure 1 on page 2) on the left side of the panel.
5. Plug in the transformer to the panel while holding the reset button and keeping the panel cover open.
6. Release the button.
7. Plug in the battery and close the panel chassis.
8. Replace the trim ring.

Applying AC power

Make sure the outlet is not controlled by a switch or that it is not part of a ground fault circuit interrupt (GFCI).

Note: For Canadian installations, plug the transformer into the wall outlet.

1. Remove the center screw from the outlet cover plate and hold the cover plate in place.

WARNING: Use extreme caution when securing the transformer to a metal outlet cover. You could receive a serious shock if a metal outlet cover drops down onto the prongs of the plug.
2. Plug the transformer into the lower receptacle of the outlet so that the hole in the transformer tab lines up with the outlet cover screw hole.
3. Insert the cover plate screw through the transformer tab and the outlet cover plate. Tighten the screw.

Note: Upon initial installation, the battery may not be fully charged for as long as 36 hours. A low battery icon will be present and trouble beeps will sound until the battery is sufficiently charged. After the initial charge, should the panel lose AC Power and experience a low battery condition, the icon will appear and trouble beeps will sound unless silenced. You can silence trouble beeps by:

- Arming or disarming the system.

or
- Pressing the STATUS & SETTINGS icon and pressing LISTEN next to Panel Status.

This will disable the sounder for 4 hours but the trouble indication will remain until the battery is recharged.







Programming

The control panel provides the main processing unit for all system functions. The programming of system options and features is menu-driven.

Table 2 below describes the panel's programming keys and features.

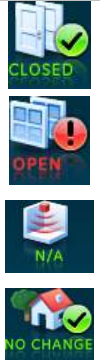
Table 2: Simon XTi features and home keys

Item	Description
Piezo siren	Provides alarm beeps and status beeps. Fire and intrusion alarm beeps are always played at high volume, while the volume of status beeps is programmable.
Touch screen	Provides a graphical user interface for programming and system operation.
Microphone	Used to communicate with the central monitoring station after an alarm.

Item	Description
Speaker	Provides voice output and sounds key beeps. The panel speaks arming level change, system status, and voice chime sensor trips. The panel voice is also used for voice reporting and remote phone control.
	To access the emergency screen and select the appropriate emergency icon (Panic, Police, or Fire), press EMERGENCY in the top left corner of the screen.
Time	Displays the current system time.
	Depicts the status of the AC power and battery. A green power cord icon represents AC power to the system. A red battery icon represents low battery power to the system. A green battery icon represents a charged battery.
	This will appear on the home screen in the event of an alarm. Messages will also display on this icon describing what caused the alarm. Press this icon to cancel the alarm.
	These four icons depict the status of the sensors installed in your system. A green check indicates sensors are closed or no recent activity detected. A red exclamation indicates sensors are open or recent activity has been detected. Pressing these icons will open a new screen to provide more detail. If the icon shows N/A, your system is not configured to support that type of sensor.
	Press this icon to access the Arming Screen.
	One of these icons will display depending on your arming level. Press to turn off intrusion/burglary protection for your system. Only intrusion/burglary sensors are disarmed. Environmental sensors, such as smoke and carbon monoxide detectors, stay active at all times. Enter your code in the keypad screen that appears. If you enter an incorrect code, press the Clear icon and enter the correct code.
	Press to access the Status & Settings screen.

Arming errors

If you select an arming option on the Arm screen, and there is an arming problem, an arming error message will appear at the bottom of the screen, indicating what the problem is and how to correct it. For example, you might see a message that indicates that you need to close the front door.

Correct the problem as indicated or press Bypass. You will see the arming countdown message at the bottom of the screen. You can touch Cancel and enter your code to stop the arming process.

Status & Settings screen

Entering and exiting the Status & Settings screen

To enter the Status & Settings screen:

Press the Status & Settings icon  on the lower right of the home screen.

To exit the Status & Settings screen:

Press Close to exit the Status & Settings screen and navigate up one level.

Note: The system will automatically return to the main screen after a period of inactivity.

A gold icon indicates an option is selected.

A blue icon indicates an option is not selected.

Status & Settings Screen navigation

1. Press the up/down arrows to scroll through the pages. (See Table 3 below for Settings screen structure).
2. Press an icon to change the value of an option or enter a subscreen.
3. Press Close to return to the previous screen.

Table 3: Status & Settings screen structure

Option	How to view
Event History	Press the Show icon to view system events. Note: If a # appears in the Event History list, the event was not sent to the central station.
Direct Bypass	Press the Select icon to enter the sensor bypass screen.
Panel Status	Press the Listen icon to listen to the status of your security system. Press Clear to clear the status.
Chime	Press the On/Off icon to set the chime feature On/Off. Note: This option may or may not appear depending on panel programming.
Special Chime	Press the On/Off icon to set the special chime feature On/Off. Note: This option may or may not appear depending on panel programming.
Lights	Press Control to access the Light screen. From there you can turn On/Off programmed lights. Note: Has not been investigated by UL.
Door Locks	Press Control to access the Door Lock screen. From there you can lock/unlock programmed door locks. Note: Has not been investigated by UL.
Voice Volume	Press the arrows to adjust the speech volume level.
Beep Volume	Press the arrows to adjust the beep volume level.
Brightness	Press the arrows to adjust the screen's brightness.

Option	How to view
Default Screen	Use this feature to set this panel's screen saver mode. Select "Blank" to have the screen and LED go dark after a period of inactivity. Otherwise, the default will be the Home screen and the screen will always be lit. If AC power is lost, the screen will go blank after 2 minutes of inactivity to maximize battery life. Note: The screen will automatically go blank at 2:00 am daily for 60 minutes.
Calibration	Press the Show icon to enter the calibration screen. This screen will allow you to recalibrate the touch screen.
Help	Press the Help icon to access the Help menu.
Set Date/Time	Press Enter to set the date and time.
System Tests	Press Enter to perform a sensor test or system download.
Programming	Press the Access Codes icon to change existing or add new access codes.
	Press the Security icon to turn downloader enable on/off and to set the account number.
	Press the Phone numbers icon to change existing or add new phone numbers.
	Press the Phone Options icon to access the following phone options: <ul style="list-style-type: none"> • Manual phone test • Fail to communicate • DTMF dialing • 300 BPS enabled • Ring hang ring • Dialer delay • Call waiting code
	Press the Sensors icon to access the learn sensor, edit sensor, and delete sensor options.
	Press the Reporting icon to access the following reporting options: <ul style="list-style-type: none"> • Opening report • Closing report • Force armed report • AC power failure report • Panel low battery report • Sensor alarm restoral report • 24 hour sensor tamper • Supervisory tamper report • No usage report • Swinger shutdown • Programming report • Fire alarm verification

Option	How to view	
	Press the Timers icon to access the following timers options: <ul style="list-style-type: none"> • Entry delay • Exit delay • No activity timeout • Audio phone test • Supervisory time • Alarm cancel window • RF timeout • Fail to open time • Fail to close time • Siren timeout • Unvacated premises • Smoke supervision 	
	Press the Touchpad Options icon to access the following options: <ul style="list-style-type: none"> • Keyfob no delay • Panic alarms • Remote TP arming 	
	Press the System Options icon to access the following system options: <ul style="list-style-type: none"> • RF jam detect • Demo mode • HW1 function • 24 hour clock 	
	Press the Siren Options icon to turn on/off the following options: <ul style="list-style-type: none"> • Panel piezo beeps • Panel voice • Panel piezo alarm • Trouble beeps • Voice chime • HW siren supervision • Silent police panic • Alarm report verify 	
	Press the Audio Verification icon to access the following audio verification options: <ul style="list-style-type: none"> • Audio mode • Fire shutdown • Fire enabled AVM • Panic talk • VOX receiver gain • VOX microphone gain • VOX microphone gain range • Manual microphone gain 	
	Press the System Tests icon to perform a sensor test, communication test, or system download test.	
	Version	Displays the system's firmware version, touch screen version, and copyright information.

Access Programming screen

1. From the Status & Settings screen, press the down arrow to scroll to the Programming option.

2. Press Enter.
3. Enter the dealer or installer code (see Table 4 below) and press OK.

Note: You have four seconds between number presses to enter the code or you will be returned to the home screen.

Note: Do not remove the panel power within 30 seconds of exiting program mode.

Table 4: Simon XTi programming codes

Code	Description
Dealer code	You can use the dealer code to program all system functions, including high-security options that are not accessible with the installer code if it is different from the dealer code. Depending on how the access code is set, the default dealer access code is 654321, 54321, 4321 (factory default), or 321. This code can be used for all programming.
Installer code	Depending on how the access code is set, the default installer code is 654321, 54321, 4321 (factory default), or 321. This code is limited to changing all but the following: Dealer code, code length, downloader code, phone lock, phone #1, phone #2, phone 1 report mode, phone 2 report mode, HW1 function.

Access codes

Table 5 below describes the Access code menu programming options.

Table 5: Access codes

Function	Default	Description
Dealer code	4321	You can use the dealer code to program all system options, including high-security options that are not accessible with the installer code if it is different from the dealer code. Changing the dealer code to differ from the installer code will prevent the installer from viewing certain fields. If you change the dealer code and enter program mode with the installer code, the installer will no longer be able to see the following: code length, downloader code, phone lock, phone #1, phone #2, phone 1 report mode, phone 2 report mode, HW1 function.
Installer code	4321	You can use the installer code to program most installer options, except for high-security dealer options.
Master code	1234	You can use the master code to arm/disarm the system and to enter user programming and bypass sensors.
User codes 1 to 8	Blank	You can use the user codes to arm/disarm the system.
Duress code	Blank	You can use the duress code in place of the master or user code to cause a silent alarm.
Code length	Four digits	Codes can be three to six digits long.

Sensors

These instructions describe how to add (learn) sensors, touchpads, and other system devices into panel memory. The panel recognizes a sensor when you press a sensor program icon, press and release a tamper switch, press a sensor test button, or put a sensor into alarm. Table 6 below describes the programming method for each device.

Note: If you are installing a sensor on a gun case, jewelry box, or a similar case, and the sensor is active in level one, you must direct bypass the sensor to avoid putting the panel into alarm when the sensor and the magnet are separated.

Mounting Recommendations:

- Where possible, install sensors within 100 feet (30 m) of the receiver. While a transmitter and receiver combination may have an open-air range of 500 feet (152 m) or more, the environment at the installation site may have a significant effect on operational range. Changing a sensor or receiver location can improve wireless communication.
- Avoid mounting sensors or receivers in areas where they will be exposed to moisture or where the operating temperature range will exceed the specified range (10 to 120 °F).
- Avoid mounting the sensor or receiver in areas with a large quantity of metal or electrical wiring. For example: within 1 meter of AC distribution panel (fuse box), HVAC duct work
- Avoid mounting the sensor or receiver directly on metal.
- The Simon XTi system should not be mounted within 3 meters of any other RF equipment (RF music system transmitter, wireless router/modem, etc.).

Note: Refer to specific sensor installation instructions for complete operation and testing details.

Table 6: Device programming

Device	To program
Door/window sensor	Press the button on the top of the sensor (cover removed) or trip the tamper.
Motion sensor	Press the button on the back of the sensor (mounting plate removed) or trip the tamper.
Smoke detector	Trip the tamper, press the test button, remove the detector from its base, or put the smoke detector into alarm.
Hardwired sensor	Separate the sensor from its magnet.
CO alarm	Trip the wall tamper by removing the sensor body from the mounting plate.
Simon XT talking touch screen	1. Press the Settings icon. 2. Press the Down arrow until the Clear and Enroll icon appears. 3. Press the Clear and Enroll icon. The touch screen should indicate it is waiting for enrollment.

Device	To program
Simon XT talking touchpad	Press the Lights off button on the touchpad six times in rapid succession. On the sixth press, the touchpad makes a longer beep.
Key fob	Press the lock and unlock buttons at the same time.

To learn (program) a sensor:

1. From the Programming screen, enter the access code from the codes listed in Table 5 on page 7. The display shows each entered access code digit as a dot.
2. Press OK. You are now in the programming screen.
3. Press Sensors.
4. Press Learn Sensor.
5. Trip the sensor (see Table 6 on page 7). The Edit Sensor screen will appear. If no further action is required (change sensor name, number, or group) proceed to step 8. To exit, press Close repeatedly.
6. To change the sensor name, number, or sensor group press the appropriate Edit icon and modify the value. To change the sensor text, press the appropriate Edit icon, then choose the item you would like to change.
7. Press Save to keep the new sensor, or Cancel to abort learning this sensor into the system (both of these choices will return you to step 5).
8. To exit, press Close repeatedly.

Sensor Naming

Please use the following guide when naming sensors:

- Sensor names must have the word “window” or “door” from the text library to interact with the touch screen Door and Windows icons on the Main screen.
- On the Edit Sensor name screen in programming, default the screen to list and not keypad. This gives the user the list of possible sensor names.
- The Motion icon is controlled by sensors that are programmed into the following groups: 15, 17, 18, 20, 28, or 32.
- The Property icon is controlled by the following sensors:
 - All sensors learned into Group 43.
 - Sensors that are not named “window” or “door”.
 - Sensors not learned into the Motion groups.
 - Sensors that are named keyfob, keychain or touchpad.

Sensor Testing

Test the sensors after all programming is completed and whenever a sensor-related problem occurs.

Note: While the sensor test is a valuable installation and service tool, it only tests sensor operation for the current conditions. You should perform a sensor test after any change in environment, equipment, or programming.

Notify the central station you will be performing a test prior to starting the test.

To test the sensors:

1. Place all sensors in their secured (non alarm) state.
2. Access the System Test screen through the Programming Screen, and then press OK.
3. Enter the dealer or installer code and press OK.
4. Press Sensor Test.
5. All learned in sensors will be displayed on this screen. Press the arrows to scroll through the pages.

Test your sensors by tripping them one at a time. The panel will display the number of transmissions received from sensors you trip. See Table 7 below for specific instructions on how to trip each sensor type.

The panel sounds beeps, and the display identifies the tripped sensor and the number of RF packets received. Each beep represents one RF packet. Count the number of beeps and refer to Table 7 below for minimum requirements. The panel displays Sn #, Name, and Rounds Detected (Packets). Scroll through to make sure all sensor have been tested.

Table 7: Sensor tripping instructions

Sensor	Instructions	Minimum packets required
Hardwire contact	Open the hardwire contact.	1
Door/window	Open the secured door or window.	6 of 8
Carbon monoxide alarm	Press and hold the Test/Hush button (approximately 5 seconds) until the unit beeps two times, and then release the button.	6 of 8
Glassbreak	Test with an appropriate glass break sensor tester.	6 of 8
Motion sensor	Avoid the motion sensor field of view for 5 minutes, and then enter its view.	6 of 8
Smoke	Press and hold the test button until the system sounds transmission beeps.	6 of 8
Key fob	Press and hold the Lock and Unlock buttons simultaneously for 3 seconds.	6 of 8
Simon XT talking touchpad	Press and hold the two Emergency buttons simultaneously for 3 seconds.	6 of 8

Sensor	Instructions	Minimum packets required
Simon XT talking touch screen	For sensor testing a 1.0. touch screen, press and hold the Emergency icon for 5 seconds. For sensor testing a 1.1 or greater touch screen, press the Settings (gear) icon, scroll down, and then press the RF Test icon.	6 of 8

6. Press Close repeatedly to exit.

Sensor Test Failure

If sirens do not beep when a sensor is tripped, use an RF Sniffer (60-401) test tool to verify that the sensor is transmitting. Constant beeps from the RF Sniffer indicate a faulty sensor. Replace the sensor.

If possible, locate sensors within 100 ft. (30 m) of the panel. While a sensor may have a range of 500 ft. (152 m) or more out in the open, the environment at the installation site can have a significant effect on transmitter range. A change in sensor location may help overcome adverse wireless conditions and can potentially be accomplished by the following:

- Reposition the sensor
- Relocate the sensor
- If necessary, replace the sensor

To reposition a sensor:

1. Rotate the sensor and test for improved sensor communications at 90 and 180 degrees from original position.
2. If poor communication persists, relocate the sensor.

To relocate a sensor:

1. Test the sensor a few inches from the original position.
2. Increase the distance from the original position and retest until an acceptable location is found.
3. Mount the sensor in the new location.
4. If no location is acceptable, replace the sensor.

To replace a sensor:

1. Test a known good sensor at the same location.
2. If the transmission beeps remain below the minimum level, avoid mounting a sensor at that location.
3. If the known-good sensor functions, contact UTC Fire & Security for repair or replacement of the problem sensor.

Sensor Testing Notes:

- Conduct sensor test in all possible environmental conditions (For example: interior doors open and closed, HVAC system on and off, wireless music system turned on and off).

- Conduct sensor test whenever changes are made to the installation environment that may impact RF performance (For example: mirrors installed, metal backed wall paper, addition of other RF equipment).
- Sensor testing should be done before and after permanent mounting.

Comm Testing

If Comm Test is not finished, it will continue to run even if you exit program mode.

Note: Complete panel programming before performing comm testing.

To perform a comm test:

1. Enter the Status & Settings menu.
2. Scroll until System Tests is listed, Press Enter.
3. Enter your master code and press OK.
4. Press Comm Test.

The panel displays if the comm test was successful or not.

Central station communication

After performing sensor tests, check that the system is reporting alarms successfully to the central station.

Note: The communication with the central station test must be done while NOT in programming mode.

To verify alarm reporting:

1. Call the central station and tell the operator that you will be testing the system.
2. Arm the system.
3. Test an emergency panic icon and trip at least one sensor of each type (fire, intrusion, etc.) to verify that the appropriate alarms are working correctly. There is a 30 second delay.
4. When you finish testing the system, call the central station to verify that the alarms were received.

Cleaning the touch screen

If necessary, use a soft cloth to clear smudges on the touch screen. Do not use glass cleaner on the touch screen.

Disposal

Dispose of all equipment in accordance with local requirements.

Specifications

Power	9 VAC, 60 Hz, 25 VA transformer minimum Rechargeable battery: 6.0 VDC, 2.1 Ah NIMH. Maximum battery charging current is 120 mA. Once the battery reaches a low battery condition, a trouble signal will be annunciated, indicating that the battery may no longer support a full alarm load. When fully charged, the battery will operate the panel without AC power for 24 hours with the panel in a normal, standby condition, followed by 5 minutes in full alarm condition (including the maximum specified auxiliary load of 250 mA).
Radio frequency	319.5 MHz
Storage temperature	-29 to 140°F (-34 to 60°C) without battery 14 to 86°F (-10 to 30°C) with battery one year shelf life
Operating temperature	32 to 120°F (0 to 49°C)
Maximum humidity	85% relative humidity, noncondensing
Auxiliary power	Unregulated 4.0 to 12.3 VDC, with a maximum of 250 mA

Regulatory information

Some installation may require configurations dictated by city/state codes, insurance, or Underwriter's Laboratories (UL). This section describes the various component and configuration listings.

Basic system:

- Control panel: Backup battery 6 V 2.1 Ah (34-070)
- Standard Class 2, 9 VAC, 25 VA power transformer (UTC Fire & Security part 22-155) or Standard, Class 2, 9 VAC, 30 VA (UTC Fire & Security part 22-153).
- Hardwired siren (13-374)

Household burglary alarm system unit (UL 1023), basic system plus the following:

- Hardwired magnetic contact (1038T) or wireless learn mode door/window sensor (60-670-95R or 60-362N-10-319.5 or 60-362N-11-319.5)
- Panel piezo beeps set to on
- Entry delay set to 45 seconds or less
- Exit delay set to 60 seconds or less
- RF time-out set to 24 hours
- Control panel alarms turned on
- Auto arm set to on
- Siren timeout set to 5 minutes or more
- Trouble beeps set to on
- RF jam detect set to on
- Hardwired siren supervision set to on
- Exit extension set to off
- Quick exit set to off

Household fire warning system (UL 985), basic system plus the following:

- Wireless smoke sensor 60-848-02-95, TX-6010-01-1 learned into sensor group 26.
- Panel piezo beeps turned on
- Control panel alarms set to on
- Siren timeout set to 4 minutes or more
- Trouble beeps set to on
- RF jam detect set to on
- Hardwired siren supervision set to on
- Smoke supervision set to on

UL 1635 digital alarm communicator system the following settings are required only if the system is set up for central station reporting:

- Phone mode 1 set to "All SIA" or "All CID"
- Automatic phone test set to 001
- RF timeout set to 4 hours
- AC power failure report set to on
- CPU low battery report set to on
- Fail to communicate set to on
- Entry delay plus the dialer delay must not exceed 60 seconds

SIA system requirements

Verified to SIA CP-01-2007 by ETL, basic system, plus if multiple annunciations are required, use hardwired siren 13-046.

Note: For UL 1635 installations, entry delay plus dialer abort delay must not exceed 60 seconds.

Table 8 below describes programming requirements to meet ANSI-SIA CP-01.

Table 8: SIA setting requirements

Function	Default setting	Required setting
Entry delay	30 seconds	30 to 240 seconds
Exit delay	60 seconds	45 to 240 seconds
Dialer delay	30 seconds	15 to 45 seconds
Auto arm	On	On
Unvacated premises	On	On
Call waiting	Off	On if reporting to central station and customer has call waiting service
Alarm cancel window	6 minutes	6 to 255 minutes, Off
System test	Enabled	Enabled
Communication test	Enabled	Enabled
Exit extension	On	On
Swinger shutdown	On (one trip)	On (one trip)
Fire alarm verify	Off	On

Function	Default setting	Required setting
Duress/panic code	Disabled	Disabled
Cross zone	Disabled	Disabled for zones with high probability of false alarms

Table 9 below describes nonprogrammable (hard-coded) system operation, as required to meet ANSI-SIA CP-01.

Table 9: Nonprogrammable system operation

Function	Operation
Silent exit	All annunciators enabled
Remote arming exit time and progress annunciation	All annunciators enabled
Abort annunciation	Enabled
Cancel report annunciation	Enabled
Recent closing	Enabled (2-minute window)
Exit error	Enabled
Restoration of power	Panel resumes operation in same arming state and disregards alarm signals from sensors for the first 60 seconds after power restoration
Cancel alarm	Enter code only

Central station reporting

Note: The panel shall not be set or programmed to place a call to a police station number that has not been specifically assigned by that police station for such service.

Caution: If call waiting is used on a non-call waiting line, successful connection to the central station may be prevented.

The panel has been tested with the following central station receivers using SIA and Contact ID reporting formats:

Before beginning installation, installers must verify that the central station is equipped with the following receivers:

- Radionics D6600 central station receiver
- Sur-Gard central station receiver with models SG-DRL2A and SG-CPM2
- CS5000 digital alarm communicator receiver

UL Canada listed installations

This section describes the requirements for CUL (UL Canada) listed installations.

Canadian standards CSA certified accessories:

- Standard Class 2, 9 VAC, 30 VA power transformer (UTC Fire & Security model 22-153-CN) or Standard Class 2, 9 VAC, 25 VA, (UTC Fire & Security model 22-155-CN).

Residential burglary alarm system unit (ORD-C1023-1974): basic system as described for UL 1023 listed installations plus:

- Hardwired magnetic contact (1038T) or wireless learn mode door/window sensor (60-670)
- Siren timeout set to six minutes or more

Residential fire warning system control unit (ULC-S545-M89): basic system as described for UL 985 listed installations plus:

- Wireless smoke sensor 60-848-02-95, TX-6010-01-1 learned into sensor group 26
- Siren timeout set to six minutes or more

FCC compliance

This equipment has been tested and found to comply with the limits for a Class B digital device, pursuant to Part 15 of the FCC rules. These limits are designed to provide reasonable protection against harmful interference when the equipment is operated in a residential environment. This equipment generates, uses, and can radiate radio frequency energy and, if not installed and used in accordance with the instruction manual, may cause harmful interference to radio communications.

Changes or modifications not expressly approved by the party responsible for compliance could void the user's authority to operate the equipment.

FCC Part 15 registration number: B4Z-910C-SIMON

IC: 1175C-910CSIMO

This Class B digital apparatus complies with Canadian ICES-001. Cet appareil numérique de la classe B est conforme à la norme NMB-003 du Canada.

Part 68. This equipment complies with Part 68 of the FCC rules and the requirements adopted by ACTA.

FCC registration number: US: B4ZAK02B55910

Canada: 1175C-910CSIXT

Ranger Equivalence 0.2B

Load Number 0.2